



3GPP LTE for TDD Spectrum in the Americas

November 2009

TABLE OF CONTENTS

TABLE OF CONTENTS	2
EXECUTIVE SUMMARY	3
1 LTE FOR MOBILE BROADBAND	3
2 LTE TDD PHYSICAL LAYER DESIGN	5
2.1 BACKGROUND	5
2.2 FRAME STRUCTURE	7
2.3 GUARD PERIODS	9
2.4 COEXISTENCE	11
2.5 HYBRID-ARQ AND CONTROL SIGNALLING	12
2.6 PERFORMANCE	13
2.7 TD-SCDMA TO LTE TDD MIGRATION	14
3 SPECTRUM	15
3.1 U.S. SPECTRUM.....	15
3.2 CANADIAN SPECTRUM	18
3.3 LATIN AMERICAN SPECTRUM	20
4 CONCLUSION	21
APPENDIX: REFERENCES	21
ACKNOWLEDGMENTS	22

EXECUTIVE SUMMARY

Mobile broadband is becoming ubiquitous throughout many parts of the Americas. To meet this growing demand for mobile broadband services, operators are making plans for deployment of LTE Frequency Division Duplex (FDD) technology. It is important, however, that operators, regulators, license holders and investors closely consider deployments of LTE for unpaired Time Division Duplex (TDD) spectrum.

The LTE ecosystem supports FDD and TDD operation. Fifteen paired (for FDD operation) and eight unpaired (for TDD operation) spectrum bands have already been identified by the 3rd Generation Partnership Project (3GPP) for LTE. This means an operator can introduce LTE in new spectrum bands where it is easiest to deploy 10 MHz or 20 MHz to carriers and eventually deploy LTE in all bands.

Operators can introduce LTE to flexibly match their existing networks, spectrum and business objectives for mobile broadband and multimedia services. LTE in FDD spectrum bands will be the first to be deployed in the Americas region. Additionally, there is a great opportunity for LTE to be deployed by operators in fragmented TDD spectrum bands.

One of the advantages of the LTE ecosystem will be the vast economies of scale from being a 3GPP technical specification that is a combined LTE FDD and TDD standard. This enables device simplicity and easy implementations, which are major factors for the economies of scale for deploying a mobile technology. Another key benefit of LTE TDD is the 3GPP evolutionary approach from TD-SCDMA to LTE, which will increase the overall LTE ecosystem and scale by including a seamless integrated option for TD-SDMA operators such as China Mobile to migrate to LTE TDD.

This paper aims to inform and encourage key stakeholders to fully understand the benefits of LTE TDD for the Americas. Mobile broadband has become a reality as the Internet generation continues to grow accustomed to having broadband access anywhere and at anytime. Thus, the next generation OFDMA-based systems such as LTE will be part of a technology solution in providing the capabilities needed to meet the demands of the marketplace.

1 LTE FOR MOBILE BROADBAND

Mobile broadband technology usage is exploding, putting a tremendous strain on already well-utilized networks and their spectrum. Several studies show that new smartphones from Apple, Research In Motion, Nokia, Motorola, Huawei and other advanced mobile devices generate the same amount of traffic as 30 cell phones with basic features, while a laptop integrated into a mobile network may generate as much traffic as 450 basic-feature phones. Based on estimates provided by Report ITU-R M.2072 from WRC-07, daily mobile traffic volume per user (including laptops, M2M and other devices) could escalate up to 20 GB by 2020 in some countries (see Report ITU-R M.2072 World mobile telecommunication market forecast, a source provided as Reference [1] of the Appendix at the end of this document).

Studies of Western Europe show extremely higher data volumes in 2020, which are illustrated in Figure 1.

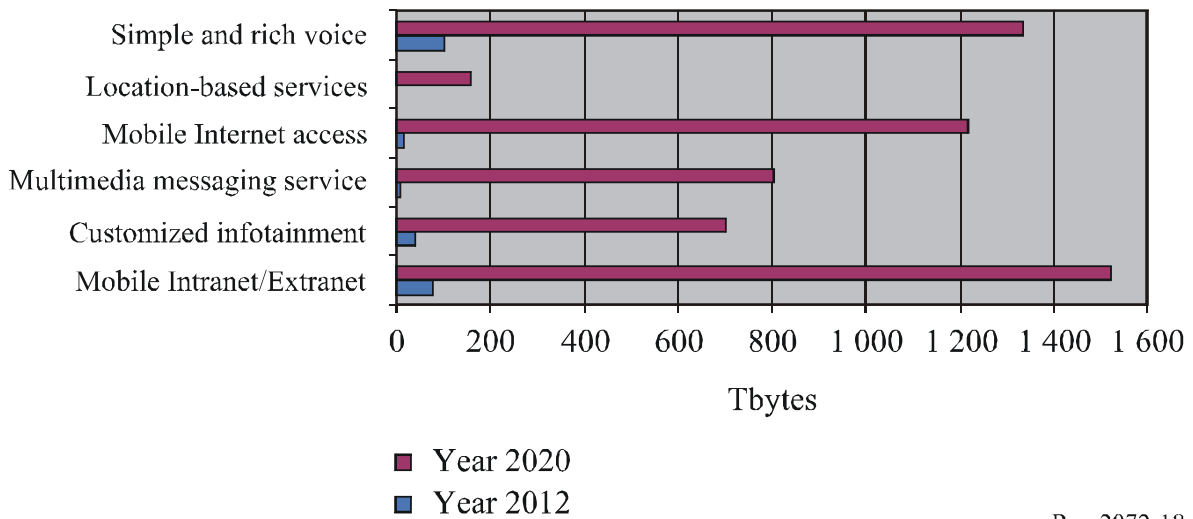

Rap 2072-18

Figure 1. Total Daily Traffic Forecast by Service Category for a Representative Western European Country: 2012 vs. 2020¹

Other studies that focus on smartphone devices offer generally similar calculations about the growth of mobile broadband. Specifically, some studies highlight that users will utilize .5 GB to 1.0 GB per month for each mobile broadband subscriber using a smartphone. Again, this surge in traffic has little to do with the number of voice calls; the bandwidth-intensive uses are typically video.

For networks as a whole, it is estimated by some analysts that mobile data traffic growth will double every year for the next four years, with the result that data usage in 2013 will be significantly greater than it was in 2008. Moreover, this growth in usage is not expected to be limited to Western Europe and Japan. Many analysts predict the highest expected growth in data usage over the next five to 10 years will be in Latin America, which is projected to see some significant data growth.

There are several technology options for mobile carriers in the Americas region; however, a robust toolkit for mobile broadband success is to follow the GSM family of technologies and the 3GPP technology standard roadmap for broadband deployments. The time is now for operators around the world to put in place their mobile broadband technology strategies with HSPA+ and LTE technologies.

According to a recent white paper by Rysavy Research for 3G Americas titled, *HSPA to LTE-Advanced: 3GPP Broadband Evolution to IMT-Advanced (4G)*, “3G technology has shown us the power and potential of always-on, everywhere network connectivity and has ignited a massive wave of industry innovation that spans devices, applications, Internet integration and new business models.”² Providing the powerful foundation of networking technologies is the GSM family – EDGE, HSPA and, in the near future, LTE – which are leading innovations and realization of global mobile broadband.

¹ *The Future of Voice – ITU Workshop*. UMTS Forum, January 2007.

² *HSPA to LTE-Advanced: 3GPP Broadband Evolution to IMT-Advanced (4G)*. Rysavy Research for 3G Americas. September 2009.

With a customer base of 4 billion connections today, the GSM family of technologies is available on nearly 800 networks in 219 countries worldwide. Building on this base, UMTS-HSPA – the world’s dominant mobile broadband technology today – has proven to be the most widely deployed and adopted 3G technology of all time, with more than 352 operators in various stages of deployment, including 277 commercial HSPA networks in 116 countries. Although HSPA and HSPA+ will continue to dominate mobile broadband subscriptions worldwide for the remainder of this decade, plans have already begun in support of the next 3GPP evolutionary step – to LTE – including announcements of trials and deployments in 2010 by leading operators such as AT&T, China Mobile, China Telecom, NTT DoCoMo, Verizon and Vodafone. There are over 100 operators that have indicated their intentions to migrate to LTE in the future. LTE using TDD spectrum will be the natural complement to mobile broadband available to the wide full demographic of society. LTE using TDD spectrum will help bridge the divide for Internet access, health, education and public safety.

3G Global Cellular Forecast 2014

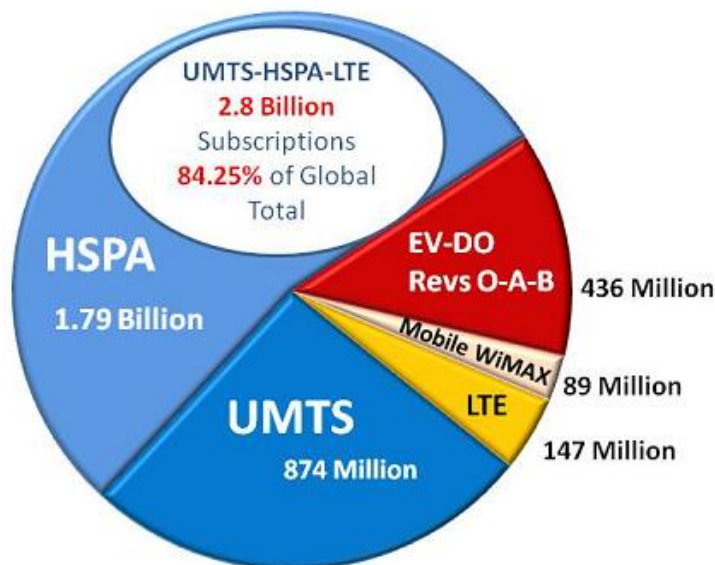

Source: Informa Telecoms & Media Forecast Summary, Q2 2009

Figure 2. 3G Global Cellular Forecast 2014

2 LTE TDD PHYSICAL LAYER DESIGN

2.1 BACKGROUND

The first release of LTE, 3GPP Release 8, provides peak rates of 300 Mbps, a significant increase in spectrum efficiency as compared to previous 3GPP technologies and a new flat radio network architecture designed to simplify operation and reduce cost. The basis for LTE is an OFDM-based downlink with its inherent robustness to frequency-selective fading, and a coverage-maximizing single-

carrier uplink. Several key features such as channel-dependent scheduling, rapid retransmission of erroneously received packets, inter-cell interference management features integrated multi-antenna schemes for spatial multiplexing and beam-forming, are all based on the basic OFDM/single-carrier transmission scheme. An in-depth description of LTE radio access and the associated flat radio-network architecture can be found in, "3G Evolution: HSPA and LTE for Mobile Broadband," by E. Dahlman, S. Parkvall, J. Sköld and P. Beming, a source provided as Reference [1] of the Appendix at the end of this document.

Depending on regulatory aspects in different geographical areas, radio spectrum for mobile communication is available in different frequency bands, of different sizes and comes as both paired and unpaired bands. Consequently, when the work on LTE started late 2004 with 3GPP setting the requirements on what the standard should achieve, spectrum flexibility was established as one of the main requirements, which included the possibility to operate in different spectrum allocations ranging from 1.4 MHz up to 20 MHz, as well as the possibility to exploit both paired and unpaired spectrum. The latter, in turn, implied both FDD and TDD to be part of the LTE specifications. Support for paired and unpaired spectrum is in itself not new to 3GPP. However, in the past this has been accomplished through different 3G radio-interface specifications (e.g. WCDMA for FDD and TD-SCDMA and TD-CDMA for TDD) resulting in dual-mode terminals being relatively uncommon so far. Therefore, it was concluded by 3GPP that support for paired and unpaired spectrum should be achieved with a minimum of technology fragmentation (see 3GPP's "TR 25.913 v7.0.0; Requirements for Evolved UTRA [E-UTRA] and Evolved UTRAN [E-UTRAN]", v7.0.0, a source provided as Reference [3] of the Appendix at the end of this document). In essence, this meant that the same solutions should be used for FDD and TDD whenever possible in order to provide a larger economy of scale benefit to both LTE FDD and LTE TDD.

Coexistence and inter-working with existing 3GPP standards, including WCDMA, TD-CDMA and TD-SCDMA, was another strong requirement for LTE in order to facilitate a smooth deployment of LTE in parallel to already existing systems. Coexistence with existing TDD RF carriers requires particular attention and an efficient and beneficial solution is to align and configure the resource allocation to uplink and downlink so that interference between the two directions is avoided.

3GPP has been successful in fulfilling its goal to achieve a single radio-access specification equally applicable to paired and unpaired spectrum. From a specification perspective, the few significant differences between FDD and TDD mode are on the physical layer and, in particular, the frame structure. The differences found on higher layers are limited to rather trivial aspects, related to configurability of the physical layer and slightly different timing relations due to the discontinuous nature of uplink and downlink.

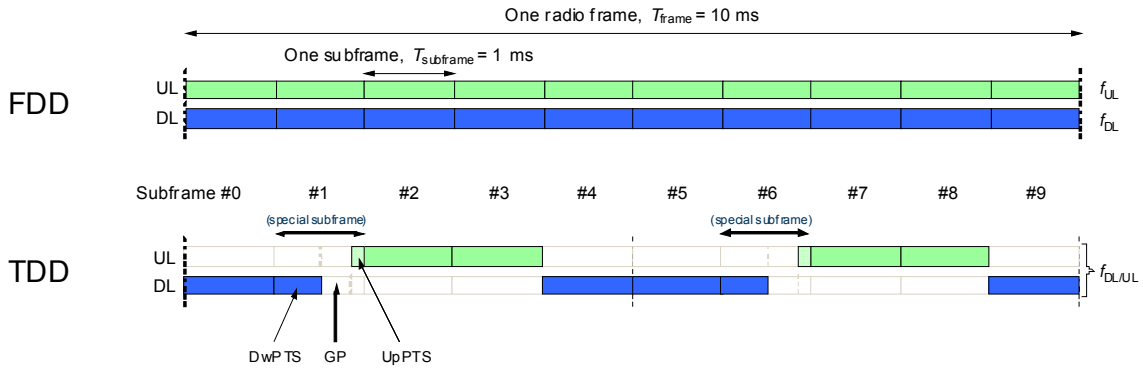

Figure 3. LTE Frame Structure

2.2 FRAME STRUCTURE

In both LTE FDD and LTE TDD, the transmitted signal is organized into subframes of 1 millisecond (ms) duration and 10 subframes constitute a radio frame. Each subframe normally consists of 14 OFDM symbols (12 OFDM symbols in case of the so-called “Extended Cyclic Prefix”). Dynamic scheduling of the uplink and downlink resources are used, where the scheduling decisions are communicated from the base station to the terminals as part of the control signaling in the first few OFDM symbols of each downlink subframe. Although the frame structure is, in most respects, the same for LTE FDD and LTE TDD, there are some differences between the two, most notably the use of special subframes in TDD as described below. Another difference is the other subframes are allocated either for uplink transmission or for downlink transmission.

In case of FDD operation (illustrated in Figure 3), there are two carrier frequencies, one for uplink transmission (f_{UL}) and one for downlink transmission (f_{DL}). During each frame, there are consequently 10 uplink subframes and 10 downlink subframes and uplink and downlink transmission can occur simultaneously within a cell.

In case of TDD operation (illustrated in Figure 3), there is only one single carrier frequency and uplink and downlink transmissions in the cell are always separated in time. As the same carrier frequency is used for uplink and downlink transmission, both the base station and the mobile terminals must switch from transmission to reception and vice versa. Thus, as a subframe is either an uplink subframe or a downlink subframe, the number of subframes per radio frame in each direction is less than 10.

To meet different requirements on uplink/downlink traffic asymmetries, LTE supports seven different uplink/downlink configurations as shown in Figure 4.

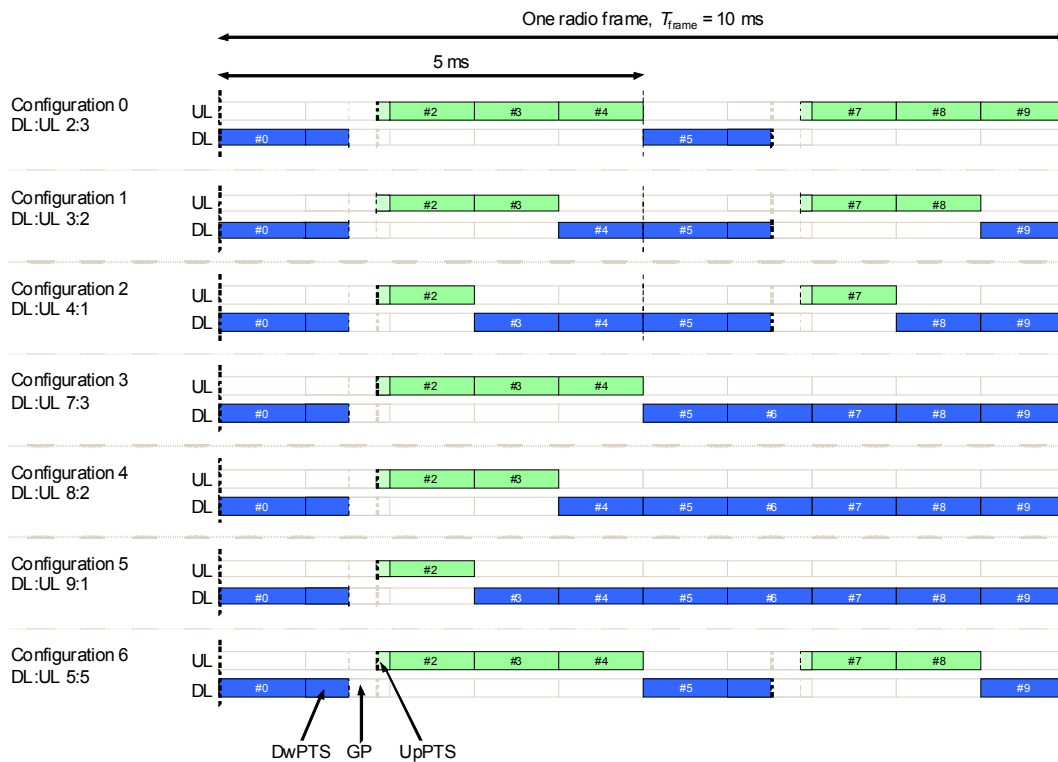

Figure 4. Uplink/Downlink Configurations

As seen in Figure 4, subframe 0 and 5 are always allocated for downlink transmission. Apart from being used for normal downlink data transmission, these subframes also convey synchronization signals allowing the terminal to obtain synchronization with the cell and acquire system information containing, among other, the uplink/downlink configuration in the cell. As illustrated in Figure 4, the periodicity of the uplink/downlink configuration is either 5 ms or 10 ms. Furthermore, if the subframes in which a switch from downlink to uplink occurs are regarded mainly as downlink subframes, downlink-to-uplink ratios from 2:3 to 9:1 can be realized. In the text that follows, configuration 0 in Figure 4 will be referred to as uplink-heavy since the number of uplink subframes is greater than the number of downlink subframes. Configurations 1-5 will for the same reason be referred to as downlink-heavy while configuration 6 is (roughly) symmetric.

To avoid severe interference between uplink and downlink transmissions despite the fact that the two links use the same frequency, the cells in a TDD network typically use the same uplink downlink configuration together with inter-cell synchronization to a common time reference to align the switch-points among all the cells. This avoids interference between the two links as uplink and downlink transmissions do not occur at the same time. This is especially important in macro deployments with antennas placed above rooftops with possible line-of-sight-like propagation conditions between base station antennas. In this case base station-to-base station interference may otherwise severely degrade

uplink reception of victim base stations. Furthermore, this kind of synchronization also avoids interference between terminals which otherwise can arise. The interference situation for TDD is then similar to FDD as shown in Figure 5.

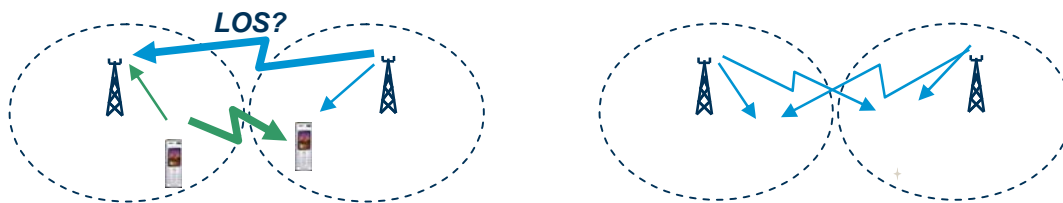

Figure 5. Interference Situation

By synchronizing to a common time reference and using the same configuration of subframes to UL and DL, interference between uplink and downlink, as shown to the left, can be avoided (as shown to the right).

2.3 GUARD PERIODS

An essential part of any TDD system is the provisioning of sufficiently large guard periods during which equipment can switch between transmission and reception with no overlap of signals to be transmitted and received. In LTE, guard periods are created through the above mentioned special subframes. In each radio frame, there are, depending on the uplink/downlink configuration, one or two special subframes. Each special subframe is split into three fields:

- 1) A downlink part (DwPTS)
- 2) A guard period (GP)
- 3) An uplink part (UpPTS)

The structure of the special subframe is seen at the bottom of Figure 3. To meet different deployment scenarios, the lengths of the three fields are configurable as further explained below.

The downlink part of the special subframe (DwPTS) may be viewed as an ordinary albeit shorter downlink subframe and is used for downlink data transmission. Its length can be varied from three up to 12 OFDM symbols. Unlike normal subframes, where the control region may span up to three OFDM symbols, the maximum control region in DwPTS is two OFDM symbols. The reason for this is the location of the primary synchronization signal in the third OFDM symbol of the DwPTS in case of TDD operation. For FDD, it is located in subframe 0 and 5. The difference in synchronization/signal location allows dual-mode terminals to detect the duplex-mode (FDD or TDD) of the cell already at initial synchronization to a carrier.

The uplink part of the special subframe (UpPTS) can have the duration of one or two OFDM symbols. The UpPTS can be used for two main purposes: transmission of uplink sounding reference signals and

random access. Sounding reference signals are known signals, transmitted from the terminals allowing the base station to estimate uplink channel quality for the purpose of for example uplink channel-dependent scheduling and link adaptation. In addition to the UpPTS, uplink channel sounding can also use the normal subframes in the same manner as in FDD. The advantage of transmitting sounding in UpPTS as compared to transmitting it in ordinary uplink subframes is that there is no impact on transmission of data and control information as in the former case. Since the radio channel is reciprocal for TDD, the uplink estimates can also be used for downlink purposes such as downlink beam-forming or precoding for multi-antenna transmission.

Random access typically uses one of the normal subframes as in FDD, allowing for a relatively long random-access preamble providing coverage and capacity also in large cells. However, in scenarios where random-access coverage is not an issue, a short random access preamble in the UpPTS can be used instead.

The remaining symbols in the special subframe which have not been allocated to DwPTS or UpPTS are used to provide the guard period, which is discussed further below.

Guard time is needed both for the downlink-to-uplink and the uplink-to-downlink switch. The Guard Period (GP) in the special subframe is split between the two through the use of the timing advance mechanism. Recall that the LTE uplink is under tight timing control of the base station to ensure that subsequent subframes from different users do not overlap in time. The base station continuously measures the timing of all received uplink transmissions and, based on these measurements, instructs the terminals to adjust their uplink transmission timing appropriately. This process is known as Timing Advance (TA). Typically, the TA is proportional to the terminal-to-base station distance, but for TDD, a slightly larger TA is applied to provide the necessary guard time for the uplink-to-downlink switch. The uplink-to-downlink switch time at the base station, T_{UL-DL} in Figure 6, is relatively short, around 20 μ s, and used for the terminal and base station to switch from uplink to downlink. The guard time can also be made larger to allow for less stringent requirements on synchronization of different cells.

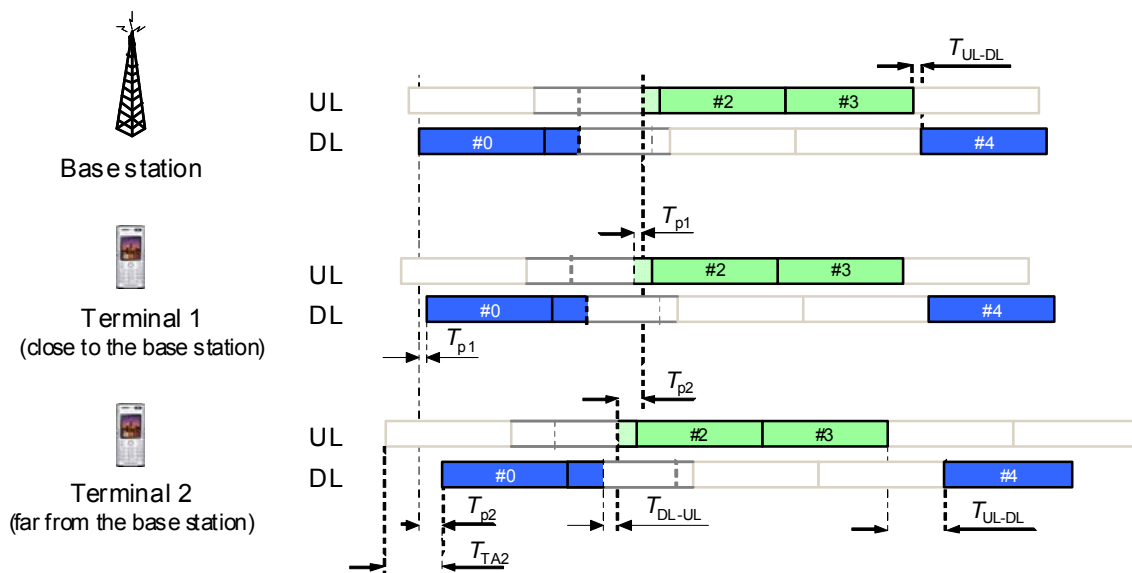

Figure 6. Guard Time for LTE TDD Operation

The largest part of the guard period is used for the downlink-to-uplink switch. The length of this guard time depends on several factors. First, the guard period must be sufficiently large to handle the propagation delay in the cell. To be time aligned at the base stations, terminals closer to the cell edge must start their transmission earlier in time than those close to the base stations as shown in Figure 6. Obviously, the transmission at a cell-edge terminal cannot start until the downlink has been completely received. Hence, the guard period needs to cover the maximum roundtrip propagation delay within the cell in addition to the time it takes for a terminal to switch from reception to transmission. To support cell ranges up to 100 km, guard periods exceeding the corresponding roundtrip propagation delay of 667 μ s are supported by LTE.

Despite the fact that the cells are synchronized to a common time reference, there can still be base station-to-base station interference. Due to the propagation delay, a downlink transmission from a distant base station is still “in the air” at the base station trying to receive uplink transmissions even though all base stations switched from downlink to uplink at the same time. This causes interference at the base station at the beginning of the uplink period. Even though it is expected to be highly scenario dependent, it may be noted that for base stations with elevated antennas and little downtilt, the propagation model in, “An Empirical Propagation Model (EPM-73),” in IEEE Transactions on Electro Magnetic Compatibility, Vol. 19, by M.N. Lustgarden and J.A. Madison – a source provided as Reference [4] of the Appendix at the end of this document – indicates that a base station under certain, but not too extreme conditions, can be heard beyond the horizon at such a large distance as 80 km. A simple way to avoid this interference is to set a large enough guard period at the expense of a relatively modest overhead of a couple percent. Other ways include more careful deployment with antenna down-tilt as well as various base station algorithms. Thus, the guard period not only is dependent on the cell size, but also may depend on the propagation conditions between the base stations.

In summary, LTE offers guard period flexibility through the special subframe which can be used to efficiently support different cell sizes up to 100 km, as well as to handle base station-to-base station interference due to relaxed synchronization requirements or propagation delays. From another perspective, guard periods are used to create orthogonality between uplink and downlink for them to have similar interference and operation as with FDD.

2.4 COEXISTENCE

An important requirement on the LTE design is compatibility and coexistence with previous UTRA radio-access technologies (see 3GPP’s “TR 25.913 v7.0.0; Requirements for Evolved UTRA [E-UTRA] and Evolved UTRAN [E-UTRAN]”, v7.0.0, a source provided as Reference [3] of the Appendix at the end of this document), such as TD-SCDMA and TD-CDMA, on adjacent carriers in the same band in the same geographical area. The interference between LTE TDD and the other system in some cases could be handled with appropriate filtering and careful deployment and spectrum guard bands. An alternative solution is to coordinate the systems such that uplink and downlink transmission are mutually aligned (i.e. the downlink/uplink switch-points should coincide between the two systems). This is enabled by having multiple uplink/downlink configurations as well as being able to configure the lengths of the fields of the special subframe. This reduces the need for guard band and eliminates potential impact of terminal-to-terminal interference, but has the drawback that compatible uplink downlink allocation must be used by different systems on adjacent carriers.

An example of coexistence between LTE TDD and TD-SCDMA is shown in Figure 7 below.

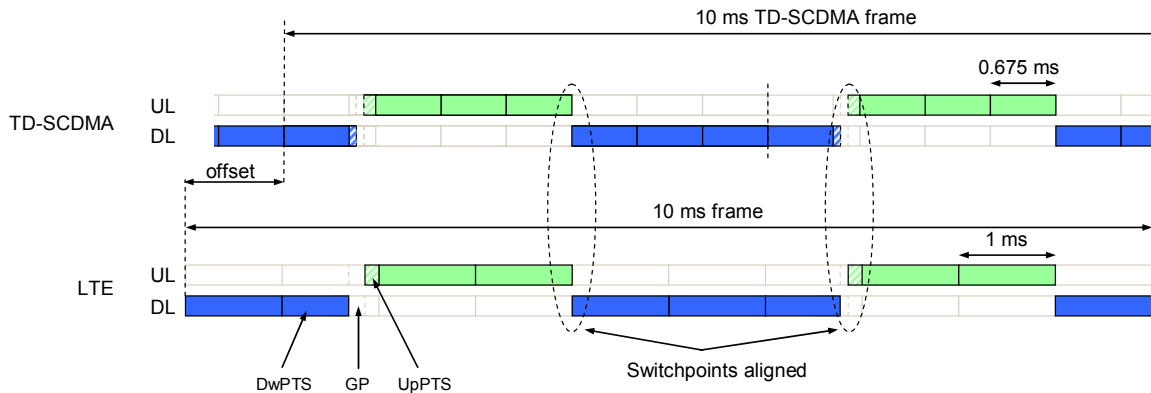

Figure 7. Example of Coexistence between LTE TDD and TD-SCDMA on Adjacent Carriers

2.5 HYBRID-ARQ AND CONTROL SIGNALLING

The possibility to configure the amount of resources for uplink and downlink leads to a significant difference between TDD and FDD. Whereas for FDD, each downlink subframe can always be associated with a corresponding uplink subframe in a one-to-one fashion, generally this is not the case and not possible for TDD as the number of uplink and downlink subframes in a radio frame typically is different.

As an example, for FDD, a fixed timing relationship has been defined such that an uplink scheduling grant received in downlink subframe n applies to uplink subframe $n+4$. This provides the terminal with sufficient time to prepare for the uplink transmission. Such a simple fixed timing relationship is not possible for TDD as, in the general case, subframe $n+4$ may not be an uplink subframe and hence other timing relations have been defined.

Another aspect is when it comes to retransmission of erroneously received data pack. For both downlink and uplink LTE utilizes hybrid-ARQ with soft combining, meaning that the terminal and the network can rapidly request retransmission of erroneously received data packets. In case the original transmission fails, the receiver buffers the soft information and combines it with the retransmission. The fundamental structure used is a set of parallel so-called hybrid-ARQ processes, where a fixed time after reception of data a positive or negative acknowledgement is transmitted. The operation of hybrid-ARQ for downlink data transfer is described in the following paragraph below. The hybrid-ARQ operation for uplink data transfer follows the same principles, although slight differences with respect to the feedback solution exist.

In each downlink subframe, data can be transmitted to one of the hybrid-ARQ processes in the terminal while the other processes are in various stages of decoding or rescheduling. By selecting the number of processes appropriately, continuous transmission to a terminal can be achieved and for FDD, the number of processes is eight.

For TDD, on the other hand, the time from reception of downlink data to transmission of an acknowledgement in the uplink depends on the uplink/downlink configuration and between four and 15

processes are needed. This comes from the fact that uplink subframes are not available at all times and the feedback therefore must be delayed at least until there is an uplink subframe.

The other main difference between LTE FDD and LTE TDD with respect to hybrid-ARQ processing is related to the transmission of acknowledgements in the uplink. For FDD, the acknowledgement of data received in subframe n is transmitted in subframe $n+4$, while for TDD, the acknowledgement obviously cannot be transmitted until an uplink subframe occurs. For the uplink-heavy and the symmetric uplink/downlink configurations, each downlink subframe has been associated with an uplink subframe in such a way that acknowledgements from at most one downlink subframe needs to be transmitted in every uplink subframe. However, in configurations where the number of downlink subframes per radio frame is larger than the number of uplink subframes, reception of several downlink subframes may need to be acknowledged in a single uplink subframe. LTE offers two mechanisms to handle this: bundling and multiplexing. Determining which mechanism to use is configured by the network on a per-terminal basis. In any case, the amount of control channel resources in an uplink subframe increases with increasing number of downlink subframes to be acknowledged.

The bundling mechanism combines the acknowledgements from multiple hybrid-ARQ processes such that a positive acknowledgement will be sent only in case all downlink transmissions were correctly received. The benefit of this approach is that the number of acknowledgement messages to be sent from a terminal in single subframe is minimized, which is important especially for coverage-limited terminals. To handle situations where the terminal misses one or several downlink assignments, and therefore may erroneously report a positive acknowledgement if data in the detected subframes is correctly decoded, there is an index in the downlink assignment from which the terminal can learn how many subframes have been assigned and hence detect whether assignments have been missed.

With multiplexing, acknowledgements from multiple hybrid-ARQ processes are explicitly transmitted in an uplink subframe. This provides more detailed information about the decoding results of the different downlink transmissions, but requires a higher signal to noise ratio at the base station and may hence not be suitable for coverage limited terminals.

For uplink data transfers, individual feedback is available and bundling is not needed. Negative acknowledgements can be transmitted in a subset of subframes for the downlink-heavy asymmetries and for the uplink-heavy configuration, there is multiplexing in one of the downlink subframes

Essentially, the same control channel formats are used for both LTE FDD and LTE TDD, the differences being how bits transmitted are interpreted and how resources are assigned.

2.6 PERFORMANCE

Considering the high degree of commonality between LTE FDD and LTE TDD, a natural question is whether the performance in terms of uplink and downlink spectrum efficiency is also similar. In general, system performance depends on the scenario, channel and traffic models and assumptions used in the evaluations. In a paper published in the April 2009 edition of IEEE Communication Magazine, titled, "LTE: The evolution of mobile broadband," (a source provided as Reference [5] of the Appendix at the end of this document), simulations of both LTE FDD and LTE TDD are presented. In short, an urban environment, 500m inter-site distance, indoor terminals, 2 GHz frequency band, and 10 MHz bandwidth

and full buffer are assumed. More details are available in the paper published in the April 2009 edition of IEEE Communication Magazine, titled, "LTE: The evolution of mobile broadband," (a source provided as Reference [5] of the Appendix at the end of this document). Generally, for non-delay sensitive traffic, the sector and edge spectral efficiencies of FDD and TDD are quite similar (marginal impact due to guard period in TDD) while for delay sensitive traffic (e.g. VoIP) there are some differences in spectral efficiencies because of different value of N in N channel stop-and-wait protocol between TDD and FDD. The spectrum efficiency, measured in bps/Hz/sector, and the average user throughput, measured in Mbps, may indeed be similar assuming that for TDD, the spectrum efficiency is calculated by downscaling the denominator (system bandwidth) with the relative time utilization (for data symbols) in the direction in question. The slightly lower performance of TDD is due to the TDD guard period, the UpPTS and slightly longer channel quality feedback delays. Note that it is the normalized throughputs that may be similar in such an interference limited case.

From an uplink link budget perspective, generally TDD has worse coverage for a given data rate, due to the inherent discontinuous uplink transmission and the fact that both FDD and TDD terminal have the same uplink transmission. This is true for any TDD system; however, for LTE, the subframe structure for both FDD and TDD are the same and the users are scheduled on a subframe basis. As such, on a subframe basis the PUSCH and PUCCH coverage for both TDD LTE and FDD LTE are similar.

2.7 TD-SCDMA TO LTE TDD MIGRATION

LTE TDD (also known as TD-LTE) and TD-SCDMA are designed to operate together with great harmonization and efficiency. If they operate on different spectrum bands there are no interference issues to be considered. Even if they are at the same spectrum band, the LTE TDD frame structure design ensures that by choosing the compatible DL:UL configurations, and by synchronizing to the same timing source, LTE TDD and TD-SCDMA can work together without interference. The TD-SCDMA cell grids and sites – including antennas, transport, power, etc. – can be reused and, therefore, help the operator to greatly save their CAPEX when rolling out LTE TDD.

IRAT between LTE TDD and legacy networks such as GSM-EDGE or TD-SCDMA are also in the roadmap. This will ensure so that the initial LTE TDD "islands" can leverage on the wider area coverage of legacy mobile networks. In September of 2009, the LTE/SAE Trial Initiative (LTSI), a global collaboration between 39 vendors and operators, completed a TDD-LTE proof of concept. The tests achieved the industry's peak spectral efficiency target of 5 bps/Hz downlink and 2.5 bps/Hz uplink in a live air test using prototype equipment while 2X2 MIMO delivered 40 Mbps and 7.3 bps/Hz spectral efficiency.

In addition, the vast synergies between LTE FDD and TDD lead to the common global ecosystem of LTE, which is unrivaled by any other mobile wireless system. LTE TDD also has similar high performance as LTE FDD in spectral efficiency, latency, etc.

Combining the above aspects, LTE TDD is widely considered as the natural evolution of TD-SCDMA and there is great potential for economies of scale and scope in infrastructure and devices because of the important Chinese operator and vendor support of TD-SCDMA and LTE TDD.

3 SPECTRUM

Many of the frequency bands in the North, Central and South America regions that are likely candidates for LTE deployments include the cellular, PCS, AWS and 700 MHz bands. As expected, it is likely and customary that these bands would use LTE FDD as these spectrum bands are mostly arranged as paired spectrum blocks. In contrast, there are spectrum blocks available that could be used in an unpaired approach and this makes the use of LTE TDD much more likely. TDD spectrum bands allocated in U.S./Canada are part of technology agnostic approach in PCS spectrum bands. Current commercial deployments in these PCS spectrum bands are FDD.

Table 1. Current 3GPP LTE TDD Spectrum

TDD		
Band	"Identifier"	Frequencies (MHz)
33,34	TDD 2000	1900-1920 2010-2025
35,36	TDD 1900	1850-1910 1930-1990
37	PCS Center Gap	(1915)1910-1930
38	IMT Extension Center Gap	2570-2620
39	China TDD	1880-1920
40	China TDD	2300-2400

3.1 U.S. SPECTRUM

In the U.S., the Broadband Radio Service (BRS) and the Educational Broadband Service (EBS) are in the 2496-2690 MHz band. While this band was previously known as Microwave Multipoint Distribution Service (MMDS), the band plan was recently rearranged and some additional rules changes were adopted. As can be seen in Figure 8 below, the spectrum blocks are not arranged as paired allocations. While a network operator could gain enough spectrum to create a pairing and thus make the use of FDD a possibility, this approach has not happened yet. Even if an FDD approach was used, it would likely require equipment and devices with small economies of scale. Currently, most systems in the BRS and EBS bands have been based on TDD (e.g. UMTS TDD and WiMAX). As LTE becomes more prevalent in the marketplace and LTE TDD equipment becomes available, it will be an option for use in the BRS and EBS bands. In addition, while the band plan in the U.S. is not completely harmonized with the European plan, there are some similarities that should help to drive development of LTE TDD for the band.

**BRS-EBS BAND PLANS: PRE-TRANSITION AT 2500–2690 MHz
& POST-TRANSITION AT 2495–2690 MHz**

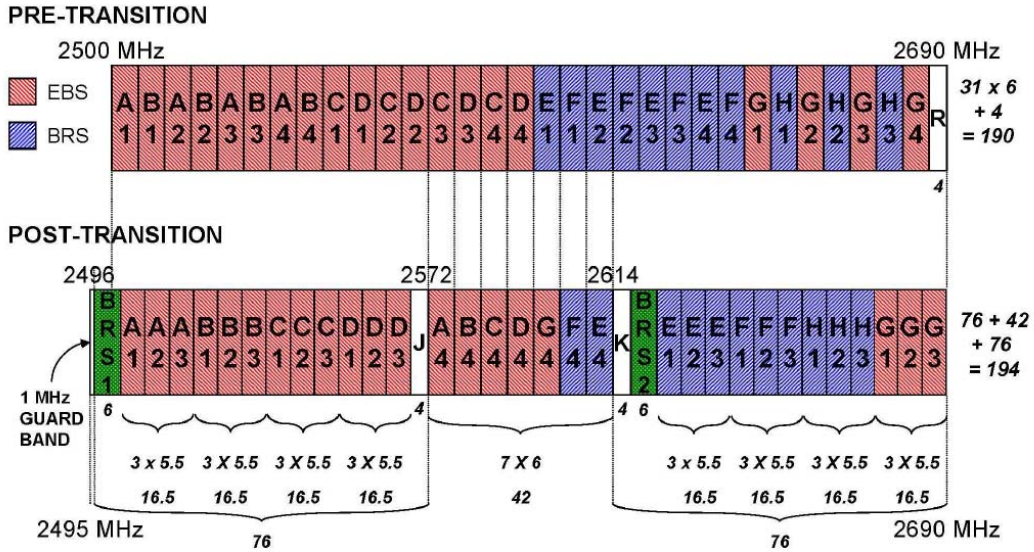

Figure 8. U.S. Band Plan for BRS and EBS Bands

Another band that could foster the development of LTE TDD is the Wireless Communications Service (WCS) in the 2300 MHz band. The band plan includes both paired and unpaired spectrum blocks which makes FDD a possibility, however, to date, most systems that are on the air in the band are using TDD. As shown in the Figure 9 below, the blocks are generally 5 MHz, paired or unpaired and a network operator could aggregate these blocks to make larger channel bandwidths possible. One drawback with the band is very low out-of-band emission levels are allowed into the Satellite Digital Audio Radio Service (SDARS) band and this has delayed the overall use (although changes to these rules are currently under consideration at the FCC).



Figure 9. U.S. Band Plan for WCS Band

It is also possible that LTE TDD could be used in other pieces of spectrum that are unpaired or otherwise unused for FDD systems. For example, the 1670-1675 MHz band was auctioned as a single nationwide license in 2003 and was thought to be eventually used for broadcast of mobile TV. To date, no

deployments have actually occurred at this spectrum band described above; however, a two-way service using LTE TDD would be one possible alternative. Similarly, the 3650-3700 MHz spectrum band is available in a “light-licensing” approach and can be used for broadband wireless access. In the case of the 3650-3700 MHz spectrum band, it is unlikely that a paired spectrum arrangement would work within the 50 MHz of spectrum and thus the use of LTE TDD would fit well in this band.

While most of the spectrum described above is in the range of 2 GHz or above, it may also be possible to use LTE TDD in spectrum below 1 GHz if larger ranges can be identified and attained. Additionally, LTE TDD has been designed to also support efficient broadcast services since it is based on OFDM/OFDMA modulation (similar to DVB-H, MediaFLO, etc.). Thus, in addition to two-way voice and data services, LTE TDD could be used for broadcast of video and other services, for example in the 1670-1675 MHz band described above.

3.2 CANADIAN SPECTRUM³

In general, the spectrum situation in Canada is similar to the one in the U.S. For example, the TDD spectrum in PCS band (1915-1930 MHz) could be used for LTE TDD since there have been virtually no deployment of unlicensed PCS technologies as originally intended.

3.2.1 AWS SPECTRUM

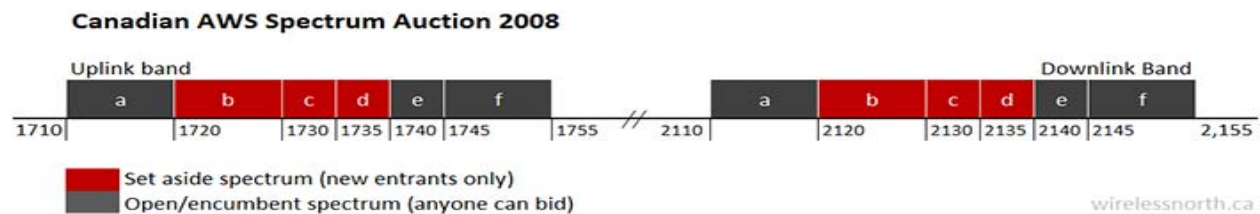

Figure 10. Canadian AWS Spectrum

Technically, Canada is auctioning three swaths of spectrum, but only one of which – the 1700 MHz – is particularly interesting for most uses. So much so, that regulators have even given it a brand name: Advanced Wireless Spectrum (AWS). The government has done something dramatic by setting aside three of the six blocks (40 percent of actual spectrum) to new entrants. The final results of Canadian AWS 2008 auction is as following:

The incumbent operators were the biggest spenders in this auction going right to the precipice of well over \$1 billion to take almost the entire A block, 20 MHz, and E and F blocks for 30 MHz. These legacy operators are expected to continue their network growth with this new AWS spectrum nationally. See Table 2.

³ In Canada the 2.5- 2.6 GHz band is under consultation between the regulatory agency and its licensees. In all countries, 3G Americas advocates technology neutrality for any spectrum re-allocation and mutual independence between FDD and TDD blocks allowing operators to choose the right technology that fulfills their business needs in each allocated band while not interfering with other technology in other bands. Proper spectrum management is neutral as to the particular air interface technology (e.g. WiMAX, UMTS-HSPA, LTE) preferred by the licensee, and should facilitate entry by licensees regardless of the technology chosen by the operator. However, this does not mean that regulators should abdicate the role of grouping “like” services together as required for efficiencies.

Table 2. Canadian AWS Tier allocations

Blocks	Pairing	Amount	Tier	Licences
A	1710-1720 MHz / 2110-2120 MHz	2x10 MHz	3	59
B	1720-1730 MHz / 2120-2130 MHz	2x10 MHz	2	14
C	1730-1735 MHz / 2130-2135 MHz	2x5 MHz	2	14
D	1735-1740 MHz / 2135-2140 MHz	2x5 MHz	3	59
E	1740-1745 MHz / 2140-2145 MHz	2x5 MHz	3	59
F	1745-1755 MHz / 2145-2155 MHz	2x10 MHz	3	59
PCS	1910-1915 MHz/ 1990-1995MHz	2x5 MHz	2	14
IMT2000	1670-1675 MHz	1x5MHz	2	14
Total	2GHz Range	105MHz	2&3	292

Several regional operators landed 10 MHz to 30 MHz bands in their local regions. The bands B, C and D were reserved for new operators and are marked in green in the table above.

What wireless operators and spectrum license holders will do with it or how aggressively they will roll out services remains to be seen. Some won more than enough spectrum to become a regional player in the cell phone business.

3.2.2 2.5 GHZ SPECTRUM BAND

The band plan for 2500-2960 MHz is under consideration. The two possible options are to either adapt the European plan or the U.S. plan.

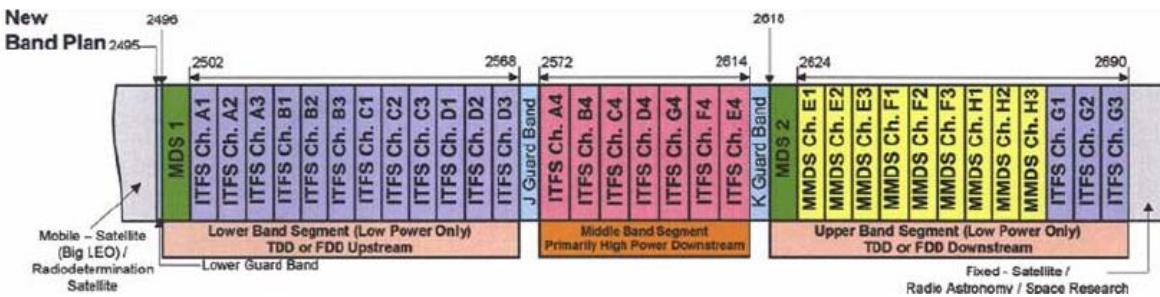

Figure 11. FCC BRS Band Plan



Figure 12. ITU-R Band Plan

There is clearly more support for the European band plan. Regardless of the final outcome, there will be unpaired spectrum for TDD deployment and, therefore, will be applicable for LTE TDD. In the event that this band is harmonized with the European plan, the Canadian market will be beneficial to the large economies of scale.

The WCS band is completely harmonized with the U.S. with the difference that there are no sub blocks within the 2x15 MHz band and license holders can subdivide the 2x15 MHz band in a way they find suitable to them. Overall, the WCS spectrum can be used by operators as paired or unpaired spectrum. Additionally, Canada has the same drawback with the spectrum band related to the restricted out-of-band emission levels of the WCS allowed into the SDARS band.

Another spectrum band that harmonized with the U.S. spectrum allocations is the 1670-1675 MHz band, which was auctioned in 2008 at the same time as the AWS band.

Similarly, technical standards for the 3650-3700 MHz band are being developed for broadband wireless access. In this case, it is unlikely that a paired spectrum arrangement would work within the 50 MHz of spectrum and so the use of LTE TDD would fit well in this band.

3.3 LATIN AMERICAN SPECTRUM

LTE is likely to be the next generation technology of choice in Latin America. As of November 2009, there are 49 operators in 24 countries that have deployed HSPA technology. The natural migration will be to move to LTE FDD when spectrum is made available. However, an often overlooked opportunity is the use of LTE TDD for Latin America. Many countries throughout Latin America have TDD spectrum in reserve for future auctions or have TDD spectrum that has been auctioned for TV or non-mobile services that has been underutilized. In fact, some countries had in the past auctioned TDD spectrum for LMDS, MMDS and broadcast services that are currently serving a small portion of society. Typically, in some countries these non-mobile license holders are serving less than 5 percent of the population while holding large amounts of spectrum that could be reutilized at its fullest capability for mobile broadband services that could serve society.

According to statistics released by industry analyst Informa Telecoms & Media, there were more than 11.7 million active UMTS-HSPA connections across Latin America as of September 2009 – an increase

of 25 percent in just one quarter. Some predict that there will be more than 14 million UMTS-HSPA subscriptions in Latin America at the end of 2009 or less than 3 percent of the total 514 million mobile subscriptions in the region. However, UMTS-HSPA subscriptions are forecast to grow to 317 million at the end of 2014, or 46 percent of the region's 689 million predicted total mobile subscriptions at that time.

LTE deployments in Latin America, however, could be a challenge since spectrum is congested in many areas. Spectrum caps in Latin America are the most restrictive in the world today: in Colombia, a maximum of 40 MHz is allowed per operator; in Argentina, 50 MHz; in Chile, 60 MHz; in Mexico, 65 MHz; and in Brazil, 80 MHz. The total amount of spectrum for all operators in each of these markets is less than 200 MHz, while the International Telecommunications Union (ITU) estimates that by 2010, 840 MHz per national market will be required to accommodate demand for mobile broadband services.

4 CONCLUSION

LTE is the next generation OFDMA-based technology of choice for most GSM and CDMA operators in the Americas. However, often overlooked is the opportunity for LTE TDD in the Americas to provide robust services to subscribers using TDD spectrum. LTE TDD was developed to take advantage of the many technical advancements as well as numerous similarities with TD-SCDMA which could enhance the LTE ecosystem. The technical synergies between TD-SCDMA and LTE are unrivaled by any other mobile wireless technology providing for a truly global ecosystem. Most LTE deployments in the Americas are currently planned for FDD spectrum; however, there is a significant amount of fragmented TDD spectrum in countries throughout the Americas that is being held by non-mobile license holders where the spectrum is not being fully maximized to fully serve societies needs. LTE TDD was standardized in 3GPP Release 8 for eight spectrum bands and offers a significant opportunity to provide mobile broadband services throughout the Americas region.

Due to the economies of scale in the migration from TD-SCDMA as well as its smart technical complementary harmonization with LTE FDD, LTE TDD mobile broadband technology is the ideal solution for operators to maximize the large amounts of unpaired TDD spectrum throughout the Americas.

APPENDIX: REFERENCES

- [1] Report ITU-R M.2072 World mobile telecommunication market forecast
- [2] E. Dahlman, S. Parkvall, J. Sköld, P. Beming, "3G Evolution: HSPA and LTE for Mobile Broadband", Academic Press, Oxford, UK, second edition, 2008.
- [3] 3GPP, "TR 25.913 v7.0.0; Requirements for Evolved UTRA (E-UTRA) and Evolved UTRAN (E-UTRAN)", v7.0.0
- [4] M.N. Lustgarden, J.A. Madison, "An Empirical Propagation Model (EPM-73)," IEEE Transactions on Electro Magnetic Compatibility, Vol. 19, No. 3, August 1977, pp 301--309
- [5] D. Astely, E. Dahlman, A. Furuskar, Y. Jading, M. Lindstrom, S. Parkvall, "LTE: The evolution of mobile broadband," IEEE Communications Magazine, April 2009

ACKNOWLEDGMENTS

The mission of 3G Americas is to promote, facilitate and advocate for the deployment of the GSM family of technologies including LTE, throughout the Americas. Members of 3G Americas' Board of Governors include Alcatel-Lucent, América Móvil, Andrew Solutions, AT&T (USA), Cable & Wireless (West Indies), Ericsson, Gemalto, HP, Huawei, Motorola, Nokia Siemens Networks, Nortel Networks, Openwave, Research In Motion (RIM), Rogers Wireless (Canada), T-Mobile USA and Telefónica.

We would like to recognize the significant project leadership and important contributions of Jan Kransmo of Ericsson as well as the other member companies from 3G Americas' Board of Governors who participated in the development of this white paper.